

For Cable DIA							
F	6.0	6.5	7.0	7.5	8.0	8.5	9.0

	A±0.2	B±0.2	C±0.2	D±0.2	E±0.1	STF-4*10.5	STB-4*12.5	SN-4*5	SSW-4
09P	31.0	47.0	15.6	12.0	25.0	2PCS	2PCS	2PCS	2PCS

ENN.CORP Chang Enn Co., Ltd.

NO.410, FU-TEH 1ST ROAD,
SHIJR, TAIPEI COUNTY
221, TAIWAN, R.O.C.
TEL: 886-2-26945824
FAX: 886-2-26946971

TITLE
D-SUB Metal Hood
(V-Type)
Short Screw
PARTS NO. PM02-09S
DWG, NO.

GENERAL TOLERANCE
DIM:
X. ±0.30
X.X ±0.20
X.XX±0.10

DRAWN	DATE	94/08/01
CHECK	DATE	103/07/22
APPROVE	DATE	
SCALE	FREE	UNIT MM REV. B

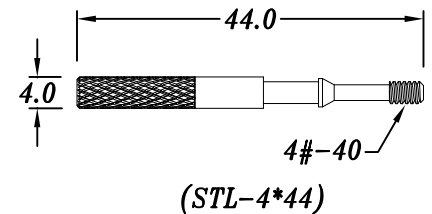
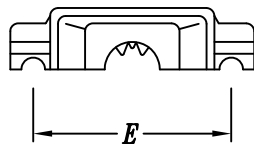
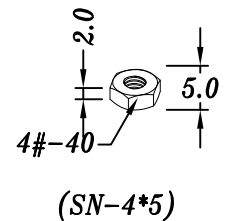
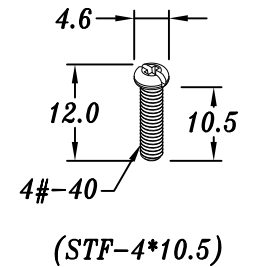
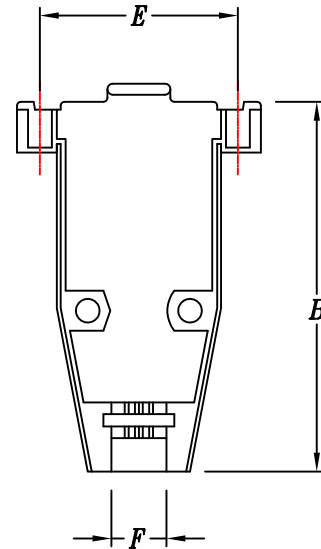
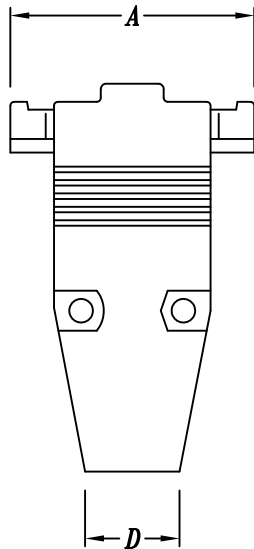
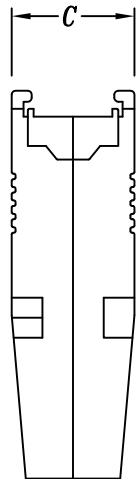
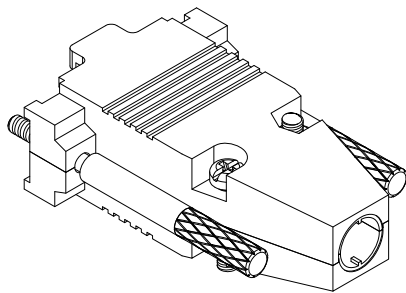

For Cable DIA							
F	6.0	6.5	7.0	7.5	8.0	8.5	9.0

	A±0.2	B±0.2	C±0.2	D±0.2	E±0.1	STF-4*10.5	SN-4*5	STL-4*44
09P	31.0	47.0	15.6	12.0	25.0	2PCS	2PCS	2PCS

ENN.CORP Chang Enn Co., Ltd.

NO.410, FU-TEH 1ST ROAD,
SHIJR, TAIPEI COUNTY
221, TAIWAN, R.O.C.
TEL: 886-2-26945824
FAX: 886-2-26946971

TITLE
D-SUB Metal Hood
(V-Type)
Long Screw
PARTS NO. PM02-09L
DWG, NO.

GENERAL TOLERANCE
DIM:
X. ±0.30
X.X ±0.20
X.XX ±0.10

DRAWN		DATE	94/08/01
CHECK		DATE	103/07/22
APPROVE		DATE	
SCALE	FREE	UNIT	MM REV. B